

Article number: 604132030020

Description: Taper bored timing belt pulley
HTD 30 8M 20 TL 1108

Measures

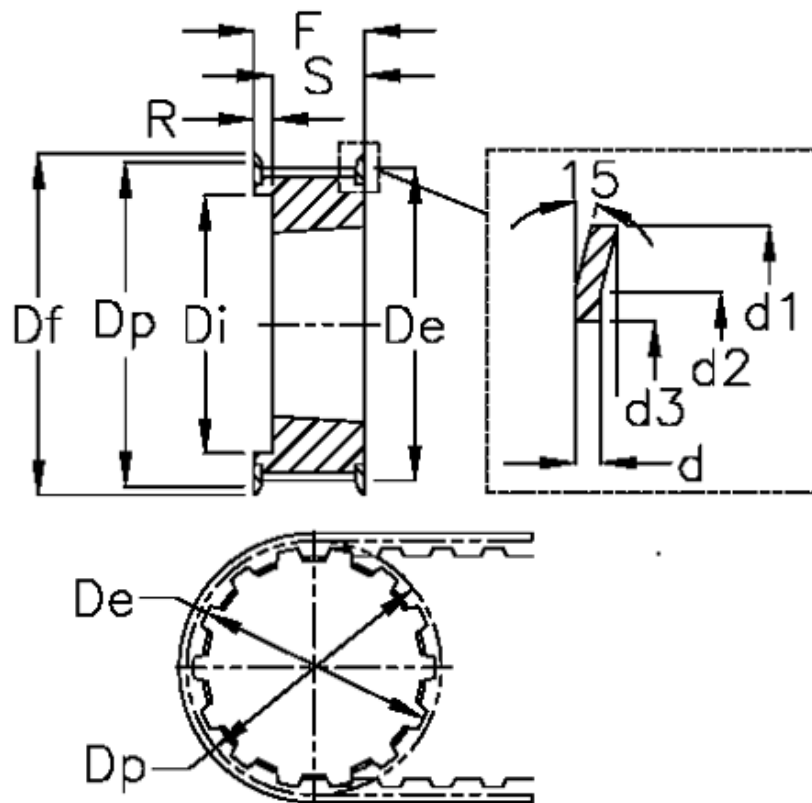

d = 1.5	F = 28	Weight = 0.53
d1 = 79	Flange type = F29	Width = 20
d2 = 72.5	For bushing = 1108	
d3 = 60	Max bore = 25	
De = 75.13	r = 6	
Df = 83	S = 22	
Di = 58	Tooth number = 30	
Dp = 76.39	Type = 8M	